

1**Smart LAN Installation****Step 1:**

Smart LAN consist by four parts. Insert the Internet cable into the nuts on the bottom, and then make the Rj45 Port for the wiring as below. Tighten the components.

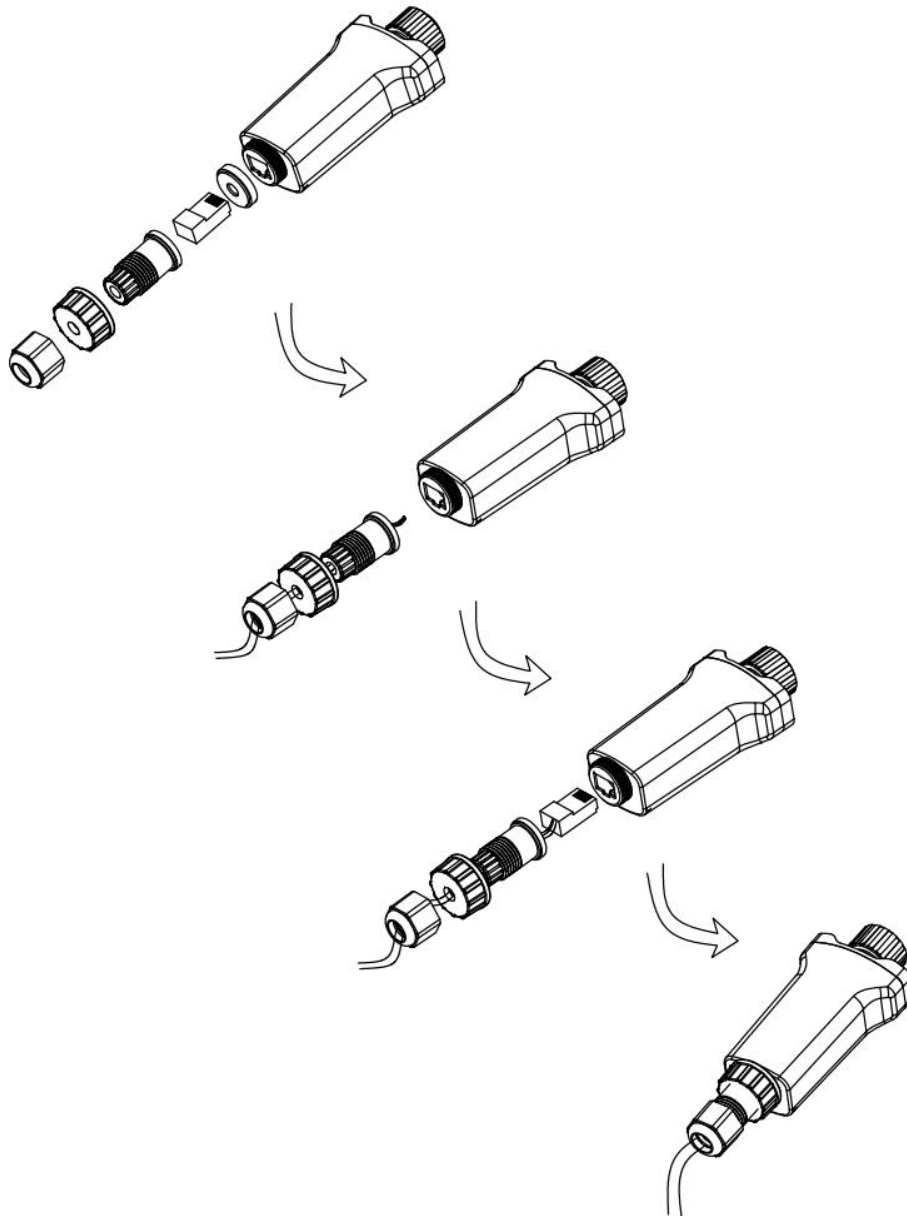

Step 2:

Insert Smart LAN into the bottom of inverter WiFi/GPRS/LAN interface.

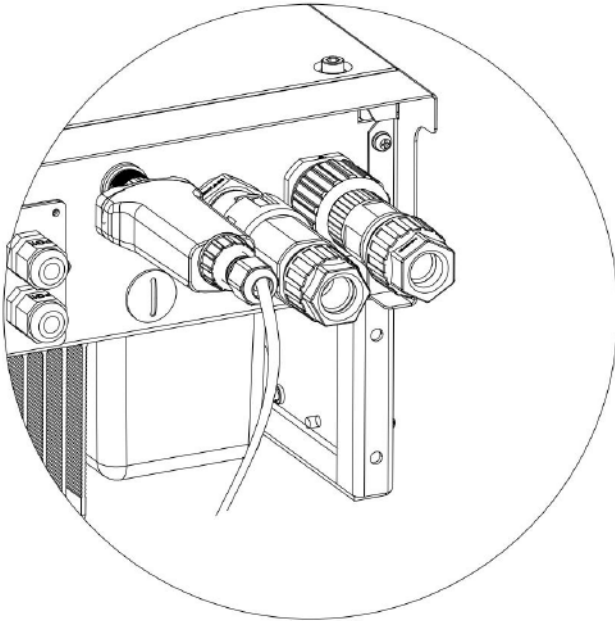

2 APP Installation

Scan the QR Code below to download and install FoxCloud APP on your smartphone or tablet.



HUAWEI AppGallery



Google Play



Apple App Store

3

Register An Account



For Installer

Step 1:

Please click 'Register', enter installer's information and click 'Next' to complete the installer account registration.

Note: If you already have an installer/agent account, please press 'Login' and enter with your installer/agent account directly.

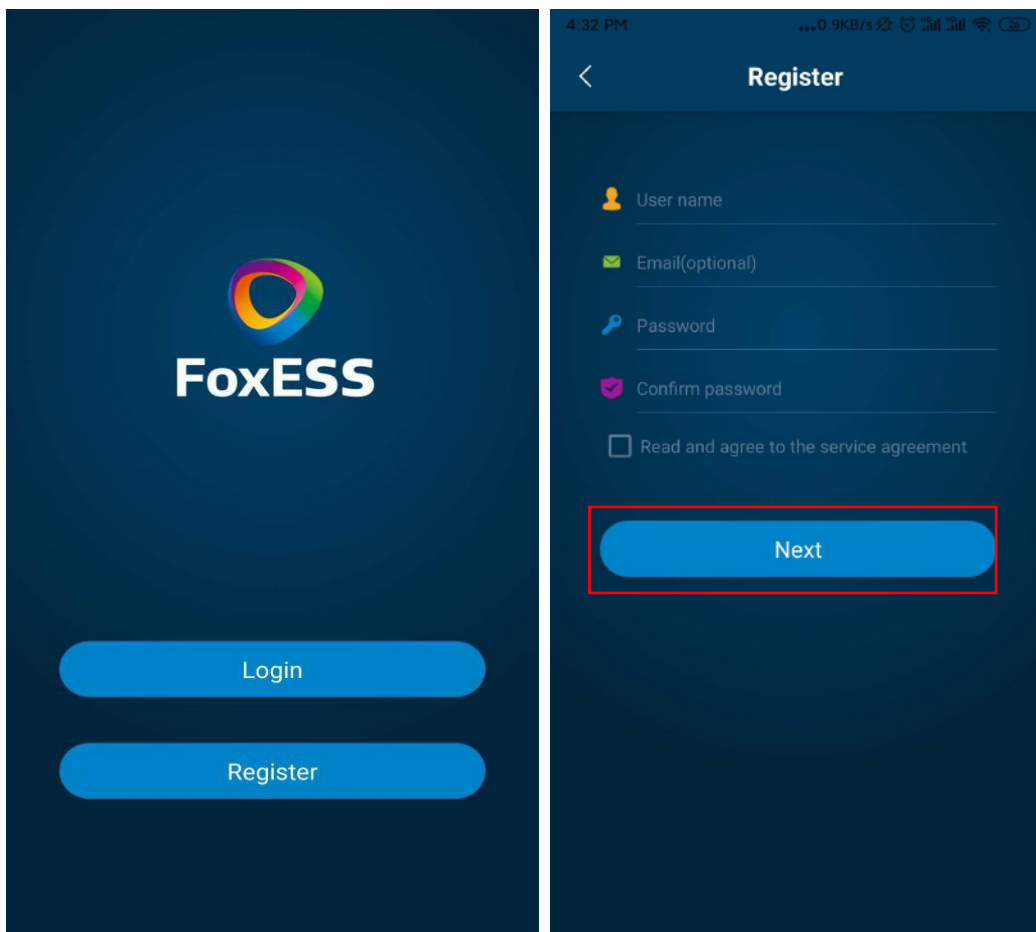

Step 2:

Select 'Installer' and enter Installer name, then click 'OK'.

We suggest that you fill in the relevant optional information to ensure after-sales service.

Note: Installer: The installer.

Agent: The agent/distributor/installation company.

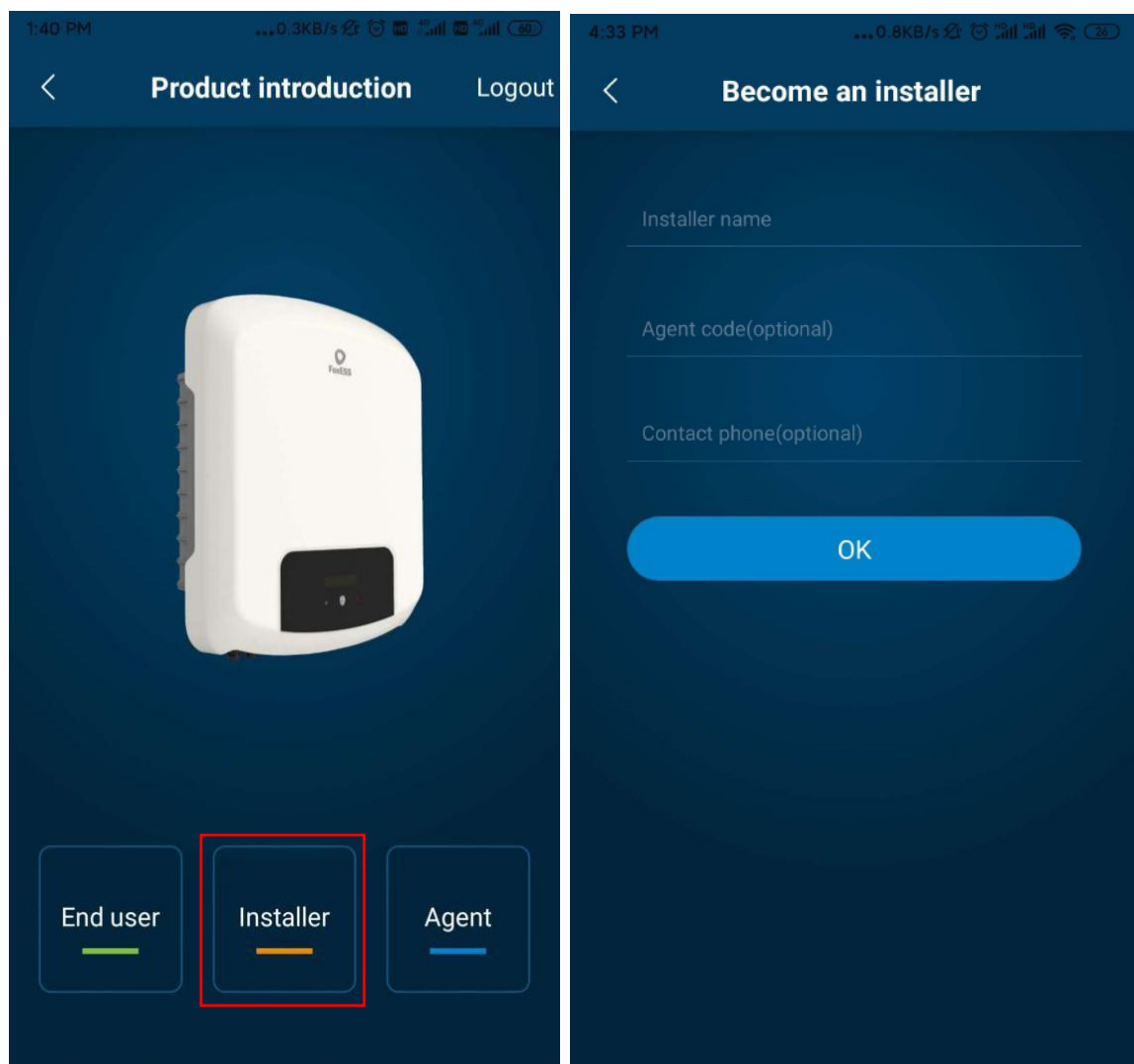

For End User

Step 1:

Please click 'Register', enter end user's information and click 'Next' to complete the end user account registration.

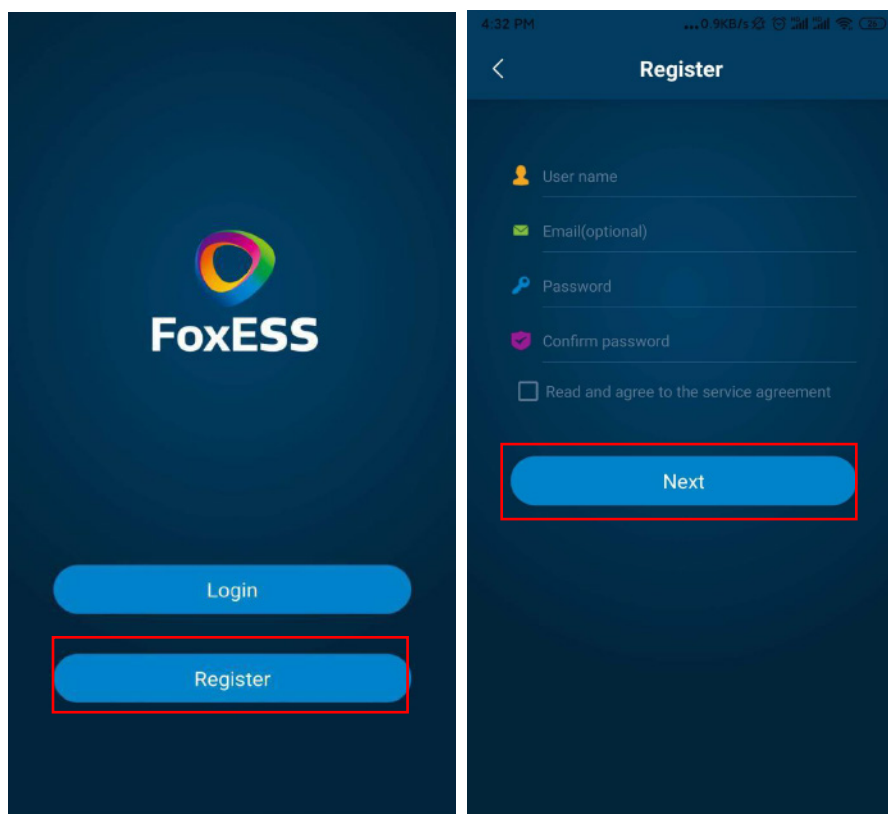

Step 2:

Select 'End user' then scan the LAN bar code on the Smart LAN, and click 'OK'.

We suggest that you fill in the relevant optional information to ensure after-sales service.

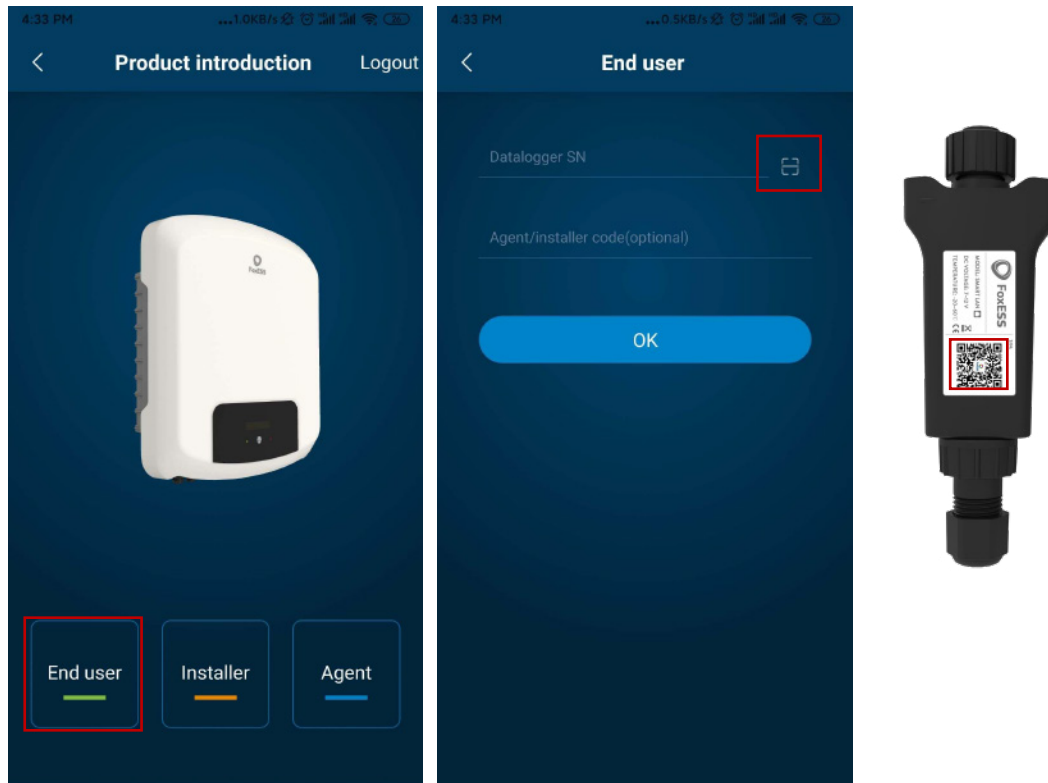

4 Create A Plant



For Installer

Step 1:

Open the APP,
login with your
Installer/agent
account.

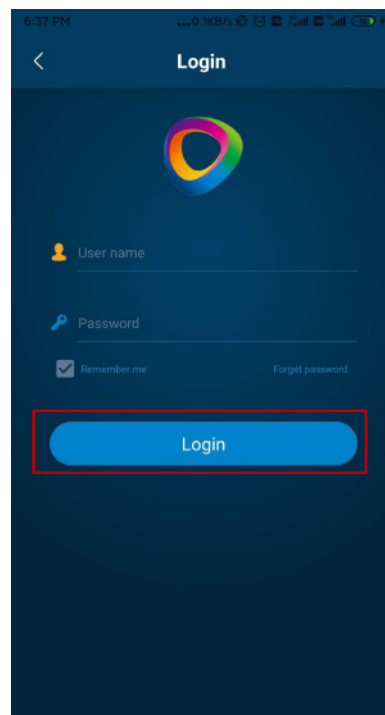

Step 2:

Press the '+' icon on the homepage to add plant. Press the scan icon next to the 'Device list' to scan the QR code label on the side of the Smart LAN.

Note: After starting the APP, it will pop-up a message 'Whether to allow positioning permissions', please select 'Allow'. For the capacity, please fill in the actual capacity of the installed solar panels.

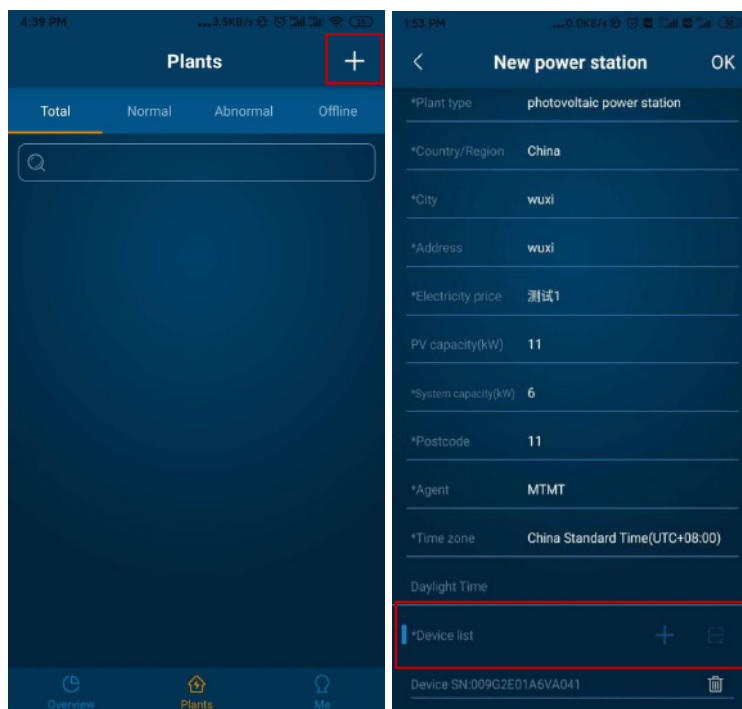



For End User

Step 1:

Open the APP, login with your end user account.

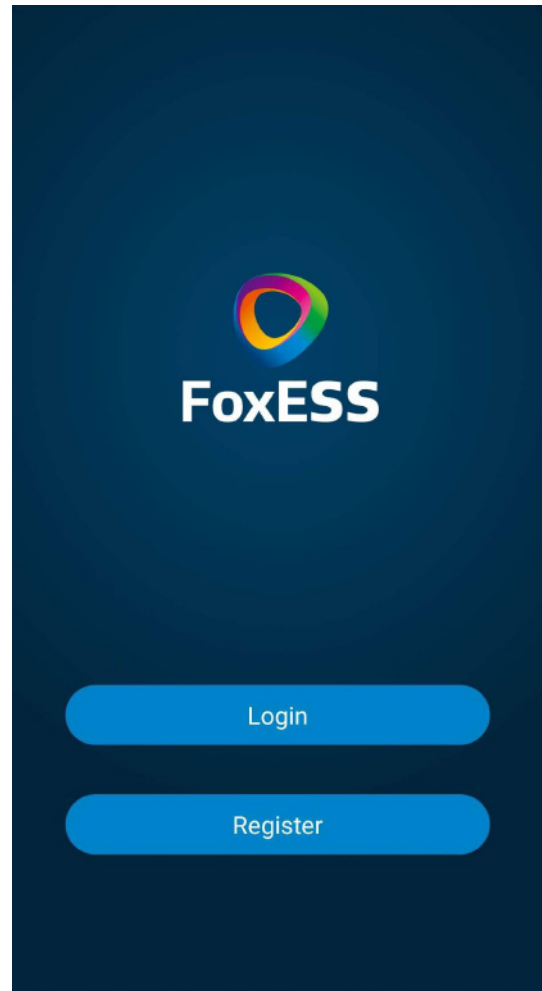

Step 2:

Press the '+' icon on the homepage to add plant. Press the scan icon next to the 'Device list' to scan the QR code label on the side of the Smart LAN.

Note: After starting the APP, it will pop-up a message 'Whether to allow positioning

permissions', please select 'Allow'. For the capacity, please fill in the actual capacity of the installed solar panels.

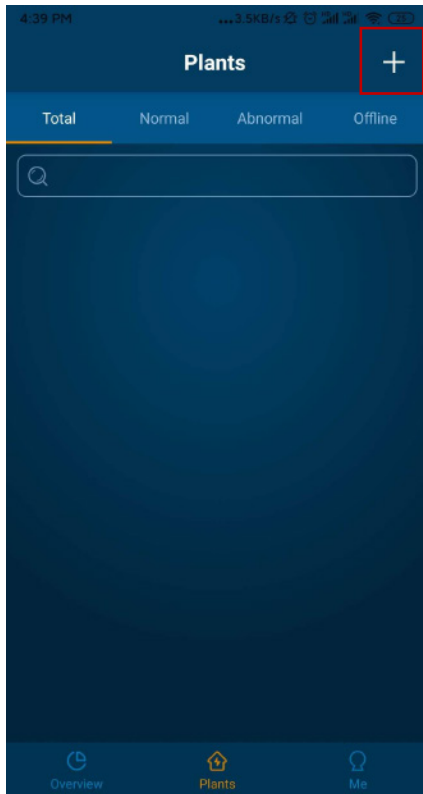

Note: If SN has been bound to the plant already, APP will jump to the beside page. If SN has not been bound before, please refer to step 3.

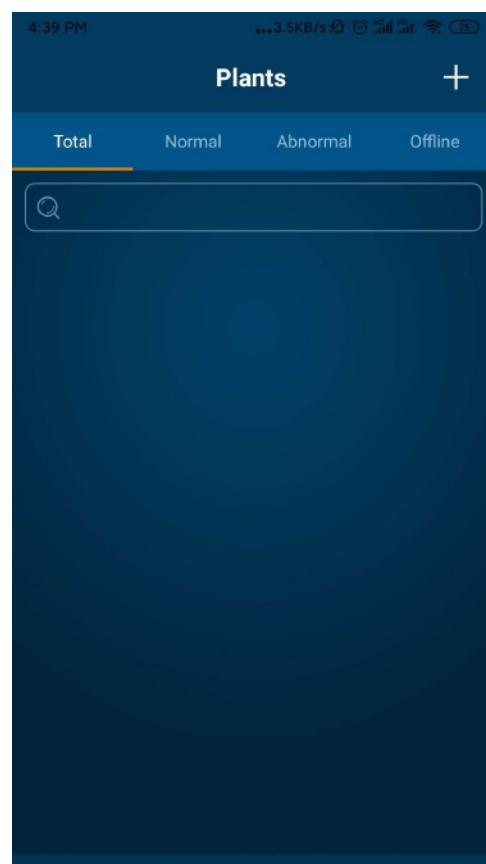

Step 3:

After scanning code successfully, click 'OK' on the top right corner of the page, APP will pop-up a message 'Add device', please click 'OK'. Complete all required information and click 'OK' on the top right corner of the page.

